

SAGINAW CONTROL & ENGINEERING SCE-90XMR3D24G SHT.1 OF 2

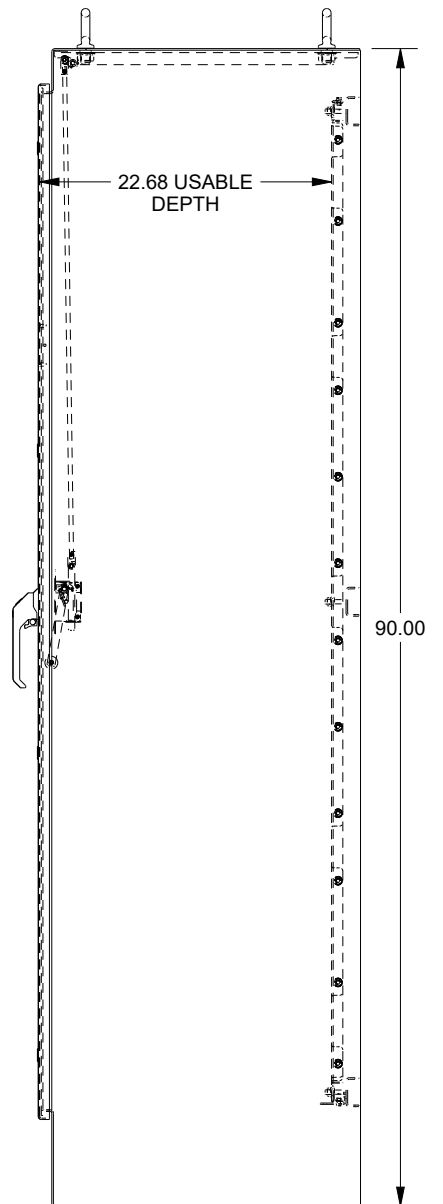

SAGINAW CONTROL & ENGINEERING

SCE-90XMR3D24G SHT.2 OF 2

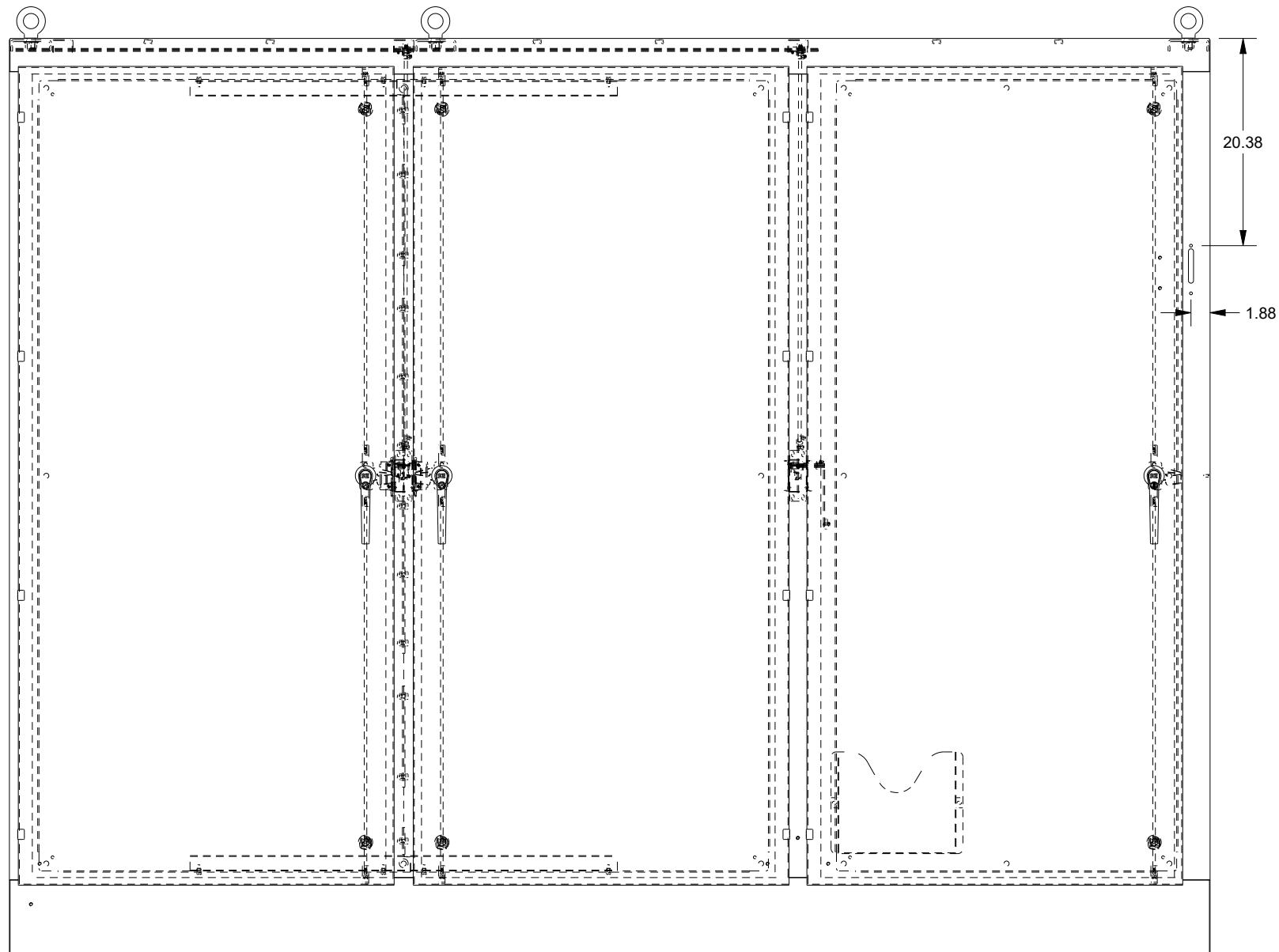
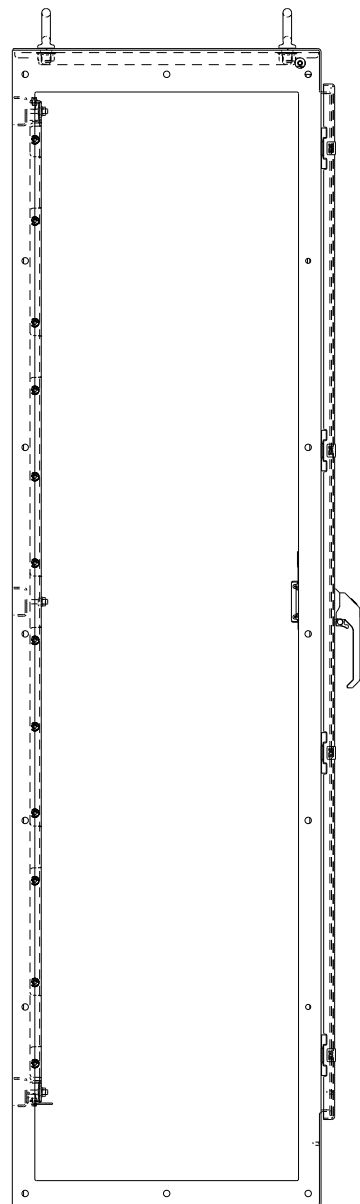
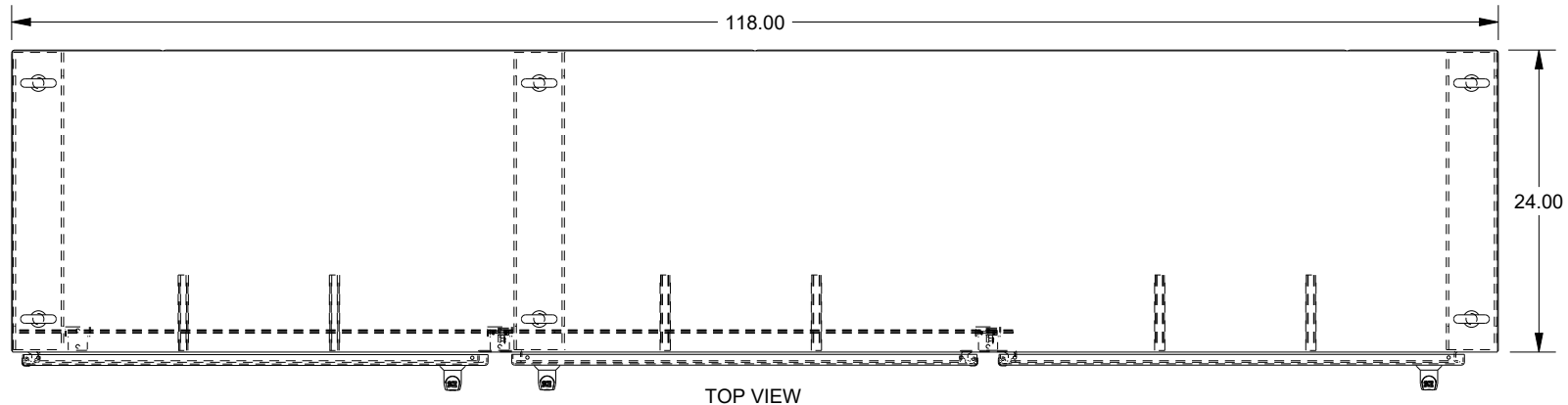
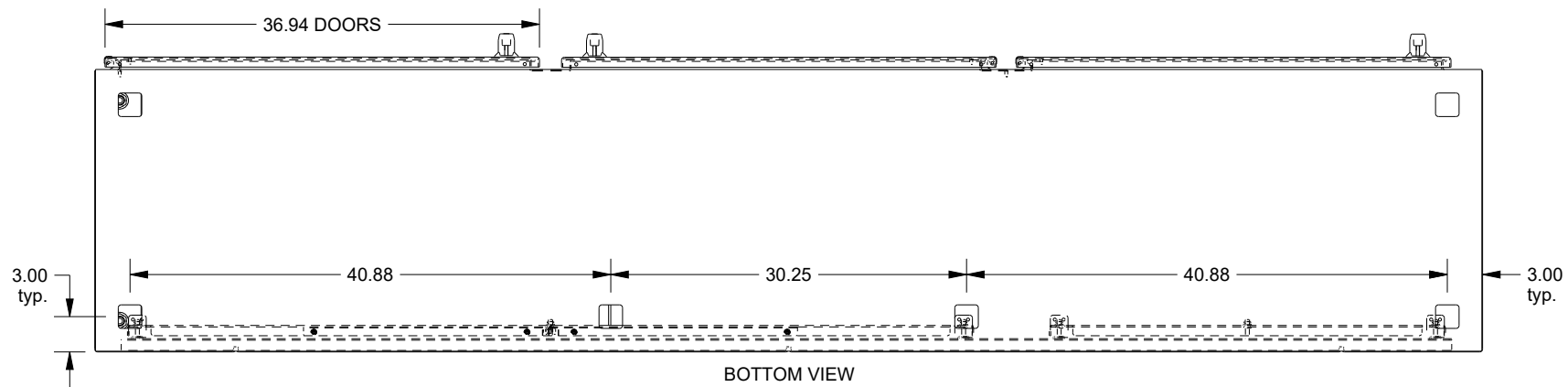
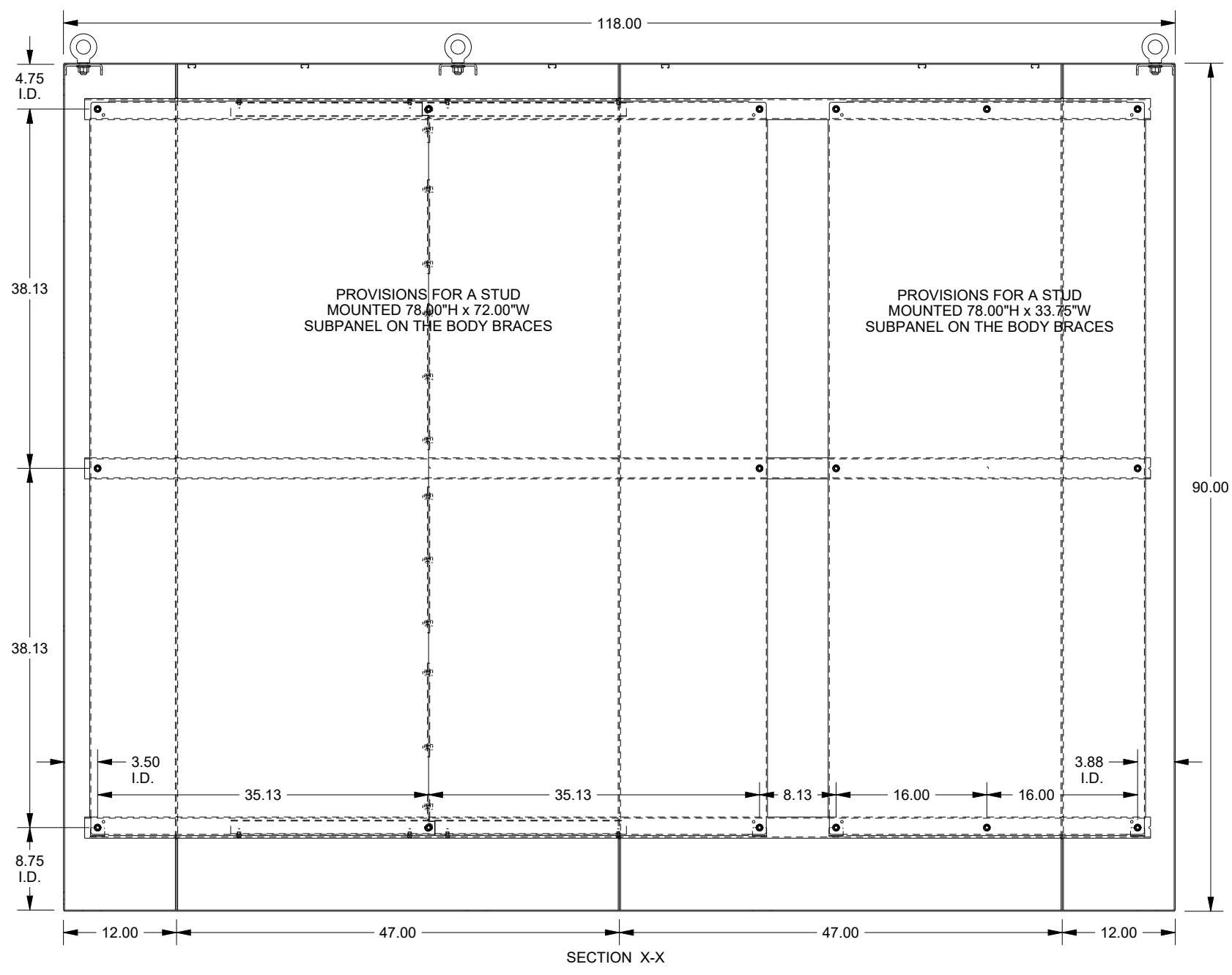
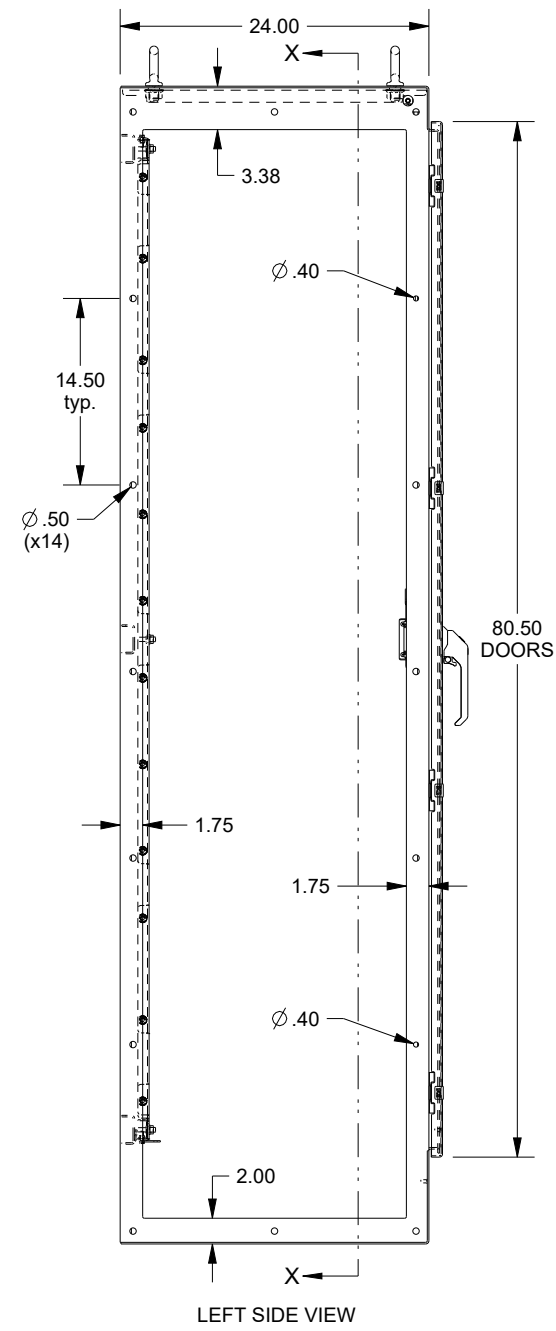

WASH SYSTEM 2" SQUARE DRAIN HOLES IN THE BOTTOM WITH UL APPROVED HOLE SEALS PROVIDED